



SCUTTI S.R.L.®

FILTRI / FILTERS

www.scuttinicola.com



MAXAIR

IT Filtro circolare a cartucce da 24 m² dotato di sistema di pulizia automatico ad aria compressa è particolarmente adatto all'installazione sui silos per filtrare la polvere proveniente dalle operazioni di carico. Il filtro si contraddistingue per le dimensioni compatte e per la tipologia costruttiva che permette una facile manutenzione in sicurezza. È possibile configurare il filtro con tramoggia ai piedi del silo come filtro di sfiato.

UK Round cartridge filter supplied with 24 m² filtering surface and air jet cleaning system, is designed to be installed on top of silo as vent filter. Minimum dimensions and quick opening devices allow full safety and trouble-free maintenance for the operator. The MAXAIR is available with dust collecting pre-separator.

DE Der Patronen-Siloaufsatzfilter (Patronen aus Polyestervlies) ist eigens als Siloaufsatzfilter entwickelt worden. Seine schmale Bauweise und das Öffnen des Oberteils mit Hilfe eines Schnelverschlusses, versprechen eine schnelle, bequeme und sichere Handhabung bei der Wartung.

ES Filtro cilíndrico de cartuchos, superficie de filtrado de 24 m² y sistema de limpieza con aire a presión. Está diseñado para ser instalado en la parte superior del silo como un filtro de venteo. Sus dimensiones compactas y el dispositivo de rápida apertura ofrecen al operador un mantenimiento sin problemas y alta seguridad. Al filtro MAXAIR se le puede instalar opcionalmente un preseparator de polvo.



 AIR JET CLEANING

FGS

IT Filtri circolari a cartucce dotati di sistema di pulizia automatico ad aria compressa sono disponibili in vari formati da 9 a 39 m² di superficie filtrante. È possibile configurare i filtri con tramoggia di raccolta ed elettroaspiratore.

UK Round cartridge filters available from 9 to 39 m² filtering surface with air jet cleaning system. The FGS is made of stainless steel and is available with dust collecting pre-separator and electric fan.

DE Der FGS-Patronen-Luffilter (Patronen aus Polyestervlies) kann als Silo Enstaubungsfilter oder mit entsprechendem Zubehör wie (Staubammeltrichter und Ventilator) als Standfilter eingesetzt werden. Die Filterfläche ist wählbar zwischen 9, 11, 19, 23, 32, 39 qm. Gehäuse in Edelstahl 14301.

ES Filtro cilíndrico de cartuchos, fabricado en acero inoxidable con superficie de filtrado entre 9 y 39 m² y sistema de limpieza con aire a presión. A los filtros FGS se les puede instalar opcionalmente un preseparator de polvo y ventilador eléctrico.



 AIR JET CLEANING

INGOMBRO IN MANUTENZIONE
DIMENSIONS ON MAINTENANCE

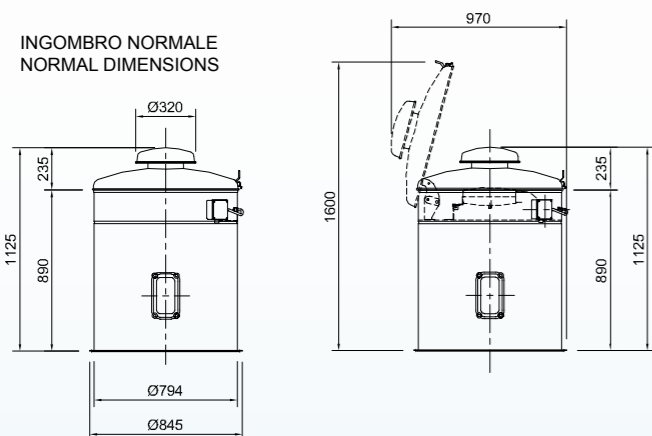

TRAMOGGIA DI RACCOLTA POLVERI
DUST COLLECTOR

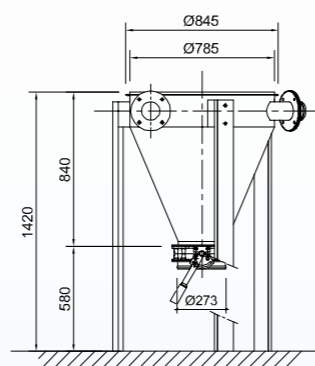

ANELLO SOTTOFILTRO A SALDARE
FILTER MOUNTING UPSTAND

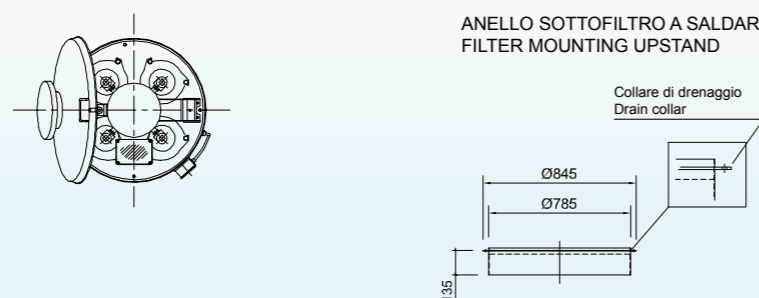

ESECUZIONE CON ASPIRATORE
ASSEMBLY WITH ELECTRIC FAN

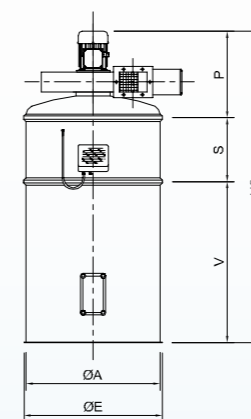

ESECUZIONE SENZA ASPIRATORE
ASSEMBLY WITHOUT ELECTRIC FAN

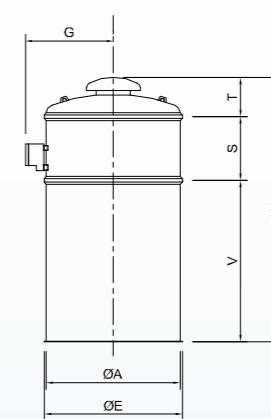

TRAMOGGIA DI RACCOLTA POLVERI
DUST COLLECTOR

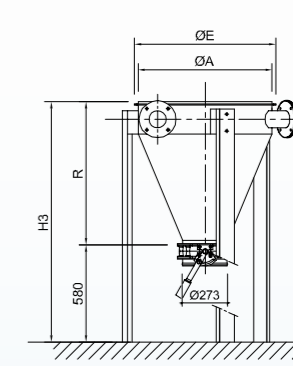

ANELLO SOTTOFILTRO A SALDARE
FILTER MOUNTING UPSTAND

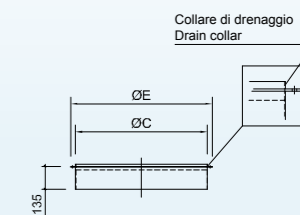

TIPO /TYPE	ØA (mm)	ØE (mm)	ØC (mm)	G (mm)	V (mm)	S (mm)	T (mm)	H1 (mm)	P (max) (mm)	H2 (mm)	R (mm)	H3 (mm)
FGS/09	600	630	585	450	810	390	235	1435	540	1740	600	1180
FGS/11					960					1585	1890	
FGS/19	800	830	785	550	810	390	235	1435	545	1745	840	1420
FGS/23					960					1585		
FGS/32	1000	1030	985	650	810	390	235	1435	640	1840	840	1420
FGS/39					960					1585		



FGV

- IT** Filtri circolari a cartucce dotati di sistema di pulizia a scuotimento mediante moto vibratore elettrico sono disponibili in vari formati da 20 a 37 m² di superficie filtrante. È possibile configurare i filtri con tramoggia di raccolta ed elettroaspiratore.
- UK** Round cartridge filters available from 20 to 37 m² filtering surface, with electric vibrator cleaning system. The FGV is made of stainless steel and is available with dust collecting pre-separator and electric fan.
- DE** Der FGV-Patronen-Rüttelfilter (Patronen aus Polyestervlies) kann als Silo Entstaubungsfiler oder mit entsprechendem Zubehör wie (Staubsammlertrichter und Ventilator) als Standfilter eingesetzt werden. Die Filterfläche ist wählbar zwischen 20,24,31,38 qm. Gehäuse in Edelstahl 14301.
- ES** Filtro cilíndrico de cartuchos, fabricado en acero inoxidable y disponibles con superficie de filtrado entre 20 y 37 m², sistema de limpieza con vibrador eléctrico. A los filtros FGV se les puede instalar opcionalmente un preseparador de polvo y ventilador eléctrico.



VIBRATION CLEANING

EKO

- IT** Filtro rettangolare a cartucce dotato di sistema di pulizia automatico ad aria compressa con sistema full immersion disponibile nei formati da 50, 72 e 86 m². Particolarmente adatto alla filtrazione delle polveri dovute al carico delle autobetoniere si adatta a diversi settori. Il filtro è costruito in acciaio al carbonio in esecuzione verniciata ed è provvisto di portello di manutenzione tramoggia di raccolta ed elettroaspiratore.
- UK** Rectangular cartridge filter supplied in 3 different sizes 50, 72, 86 m² filtering surface, made of mild steel with full immersion air jet cleaning system. EKO filter is designed for dust collection from tack mixer inlet during the loading procedure and is available with dust collecting pre-separator maintenance door and electric fan.
- DE** Der Rechteck-Patronenfilter (Patronen aus Polyester) dient vorwiegend zur Entstaubung von Silos und Behältern (Betonmischanlagen). Er dient sowohl als Aufsatzfilter wie auch als Standfilter mit dem Zubehör wie: (Staubsammlertrichter und Ventilator). Die Filterfläche ist wählbar zwischen 50,72,86 qm. Gehäuse in Normalstahl lackiert.
- ES** Filtro rectangular de cartuchos, fabricado en acero al carbono. Disponible en tres tamaños según superficie de filtrado de 50, 72 y 86 m². Sistema de limpieza con aire a presión tipo "full immersion". El filtro EKO está diseñado para la colección del polvo emitido durante el procedimiento de carga de camiones cisterna. Incluye ventilador eléctrico y puerta para el mantenimiento del preseparador de polvo.



AIR JET CLEANING

ESECUZIONE CON ASPIRATORE
ASSEMBLY WITH ELECTRIC FAN

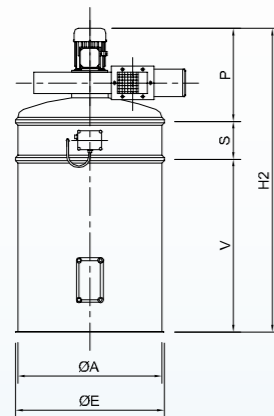

ESECUZIONE SENZA ASPIRATORE
ASSEMBLY WITHOUT ELECTRIC FAN

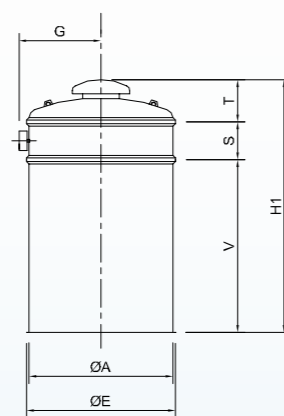

TRAMOGGIA DI RACCOLTA POLVERI
DUST COLLECTOR

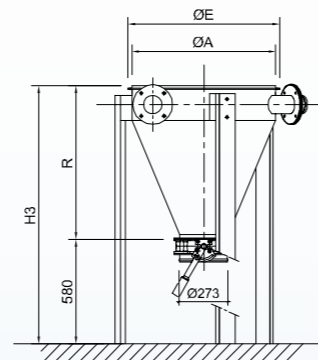

ANELLO SOTTOFILTRO A SALDARE
FILTER MOUNTING UPSTAND

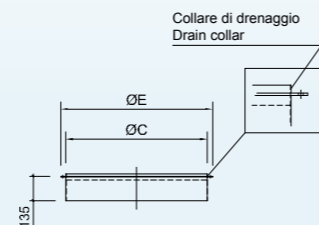

TIPO /TYPE	ØA (mm)	ØE (mm)	ØC (mm)	G (mm)	V (mm)	S (mm)	T (mm)	H1 (mm)	P (max) (mm)	H2 (mm)	R (mm)	H3 (mm)
FGV.20	800	845	785	450	810	210	235	1255	545	1565	840	1420
FGV.24					960			1405				
FGV.31	1000	1030	985	550	810			1255	640	1660		
FGV.38					960			1405				

ESECUZIONE EKO...B0 SENZA ASPIRATORE
ASSEMBLY EKO...B0 WITHOUT ELECTRIC FAN

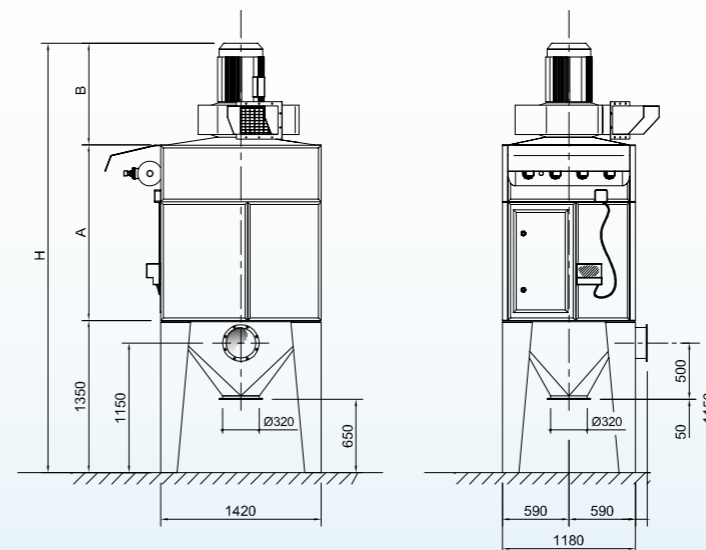
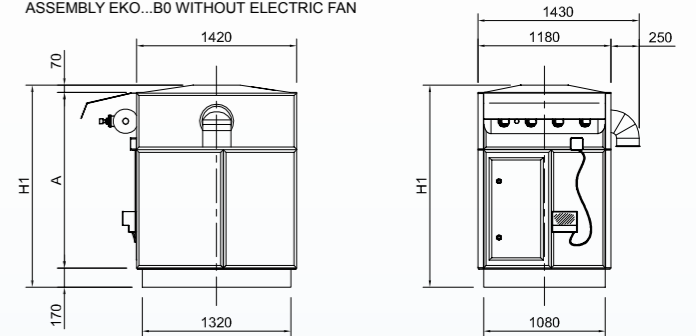



TIPO /TYPE	A (mm)	B max (mm)	H (mm)	H1 (mm)
EKO.50.A	1260	740	3350	-----
EKO.50.B0	1260	-----	-----	1500
EKO.72.A	1560	900	3810	-----
EKO.72.B0	1560	-----	-----	1800
EKO.86.A	1760	900	4010	-----
EKO.86.B0	1760	-----	-----	2000

FGM

 Filtri circolari a maniche dotati di sistema di pulizia automatico ad aria compressa sono disponibili in vari formati da 9 a 15 m² di superficie filtrante. È possibile configurare i filtri con tramoggia di raccolta ed elettroaspiratore.

 Round bag filters supplied from 9 to 15 m² filtering surface with air jet cleaning system. The FGM is made of stainless steel and is available with dust collecting pre-separator and electric fan.

 Der FGM-Schlauch-Luftfilter (Schläuche aus Nadelfilz) kann als Silo Enstaubungsfilter oder mit entsprechendem Zubehör wie (Staubsaugtrichter und Ventilator) als Standfilter eingesetzt werden. Die Filterfläche ist wählbar zwischen 9,10,15 qm. Gehäuse in Edelstahl 14301.

 Filtro cilíndrico con manga colectora, fabricado en acero inoxidable con superficie de filtrado entre 9 y 15 m² y sistema de limpieza con aire a presión. A los filtros FGM se les puede instalar opcionalmente un preseparador de polvo y ventilador eléctrico.



MINIDUST

 Filtro circolare a cartucce dotato di sistema di pulizia automatico ad aria compressa disponibile in tre formati 2,4,6 m² di superficie filtrante. Il filtro è adatto a filtrare modeste quantità di polveri e viene normalmente montato su pese o piccole tramogge di raccolta. Il filtro è costruito in acciaio al carbonio in esecuzione verniciata.

 Small cartridge filter available in three sizes 2, 4, 6 m² filtering surface, made of mild steel with air jet cleaning system. The compact design allow the installation of this filter on weight-hoppers or small tanks.

 Der Einpatronen-Enstaubungsfilter (Patronen aus Polyestervlies) dient vorwiegend zur Entstaubung von kleinen Behältern und von Waagenbehälter. Die Filterfläche ist wählbar zwischen 2,4,6 qm. Gehäuse in Normalstahl lackiert.

 Filtro de cartucho pequeño y sistema de limpieza con aire a presión; fabricado en acero al carbono y disponible en tres tamaños según superficie de filtrado, de 2, 4 y 6 m². Su diseño compacto permite la instalación de este filtro sobre tolvas de pesaje o en pequeños tanques.



ESECUZIONE CON ASPIRATORE
ASSEMBLY WITH ELECTRIC FAN

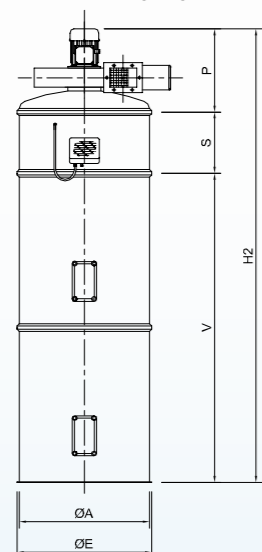

ESECUZIONE SENZA ASPIRATORE
ASSEMBLY WITHOUT ELECTRIC FAN

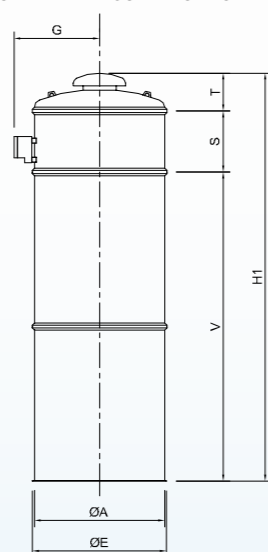

TRAMOGGIA DI RACCOLTA POLVERI
DUST COLLECTOR

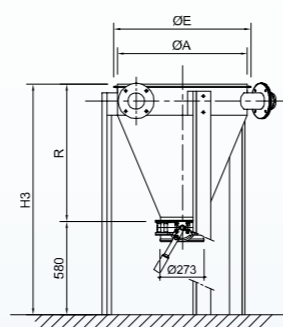

ANELLO SOTTOFILTRO A SALDARE
FILTER MOUNTING UPSTAND

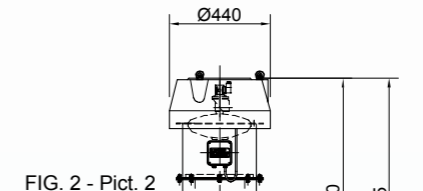
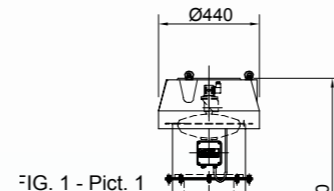
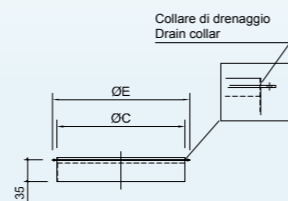

Tramoggia pesatrice
Weighing hopper

Tramoggia pesatrice
Weighing hopper

TIPO /TYPE	ØA (mm)	ØE (mm)	ØC (mm)	G (mm)	V (mm)	S (mm)	T (mm)	H1 (mm)	P (max) (mm)	H2 (mm)	R (mm)	H3 (mm)
FGM.05	600	630	585	450					540	2550	600	1180
FGM.10	800	830	785	550	1620	390	235	2245	545		840	1420
FGM.15	1000	1030	985	650					640	2650		

TIPO /TYPE	FIG. PICT.	GRANDEZZA SIZE (m ²)	PORTATA CAPACITY (m ³ /h)
MINIDUST-02	1	2	145
MINIDUST-04		4	290
MINIDUST-06	2	6	430



Naturally Inspired
Naturally Inspired
dal 1967

————— DISTRIBUTORE: —————



SCUTTI S.R.L.[®]

66043 Casoli (Chieti) Italy - C.da Vicenne, 17

Tel. +39 0872/985249 +39 0872 985414

Fax +39 0872/985117

www.scuttinicola.com info@scuttinicola.com